

Metal Core PTFE Seated Ball Valve with Relief Hole

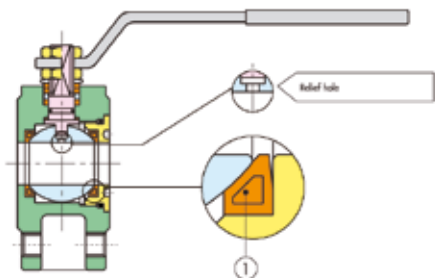

Available sizes from 1/2" to 4"

Pos.	Part Name	Materials	N°P
1	Ball Seat	P.T.F.E. + Metal Core	2

Three Piece Ball Valve with Integral Seat

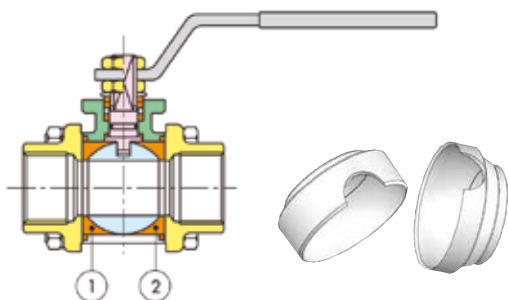

Three piece ball valve with integral seats, full bore from 1/4 to 4

Pos.	Part Name	Materials	N°P
1	Ball Seat	P.T.F.E.	1
2	Ball Seat	P.T.F.E.	1

Wafer Ball Valve with Integral Seat

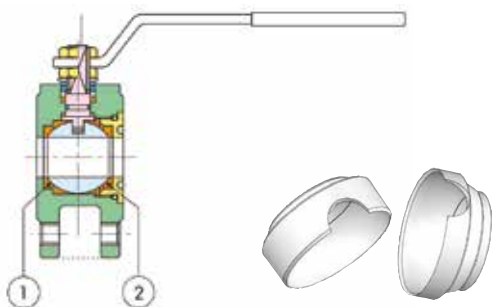

Flanged ball valve with integral seats, full bore from DN15 to DN100

Pos.	Part Name	Materials	N°P
1	Ball Seat	P.T.F.E.	1
2	Ball Seat	P.T.F.E.	1

Locking Handle (Padlock excluded)

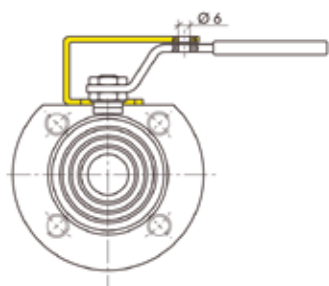
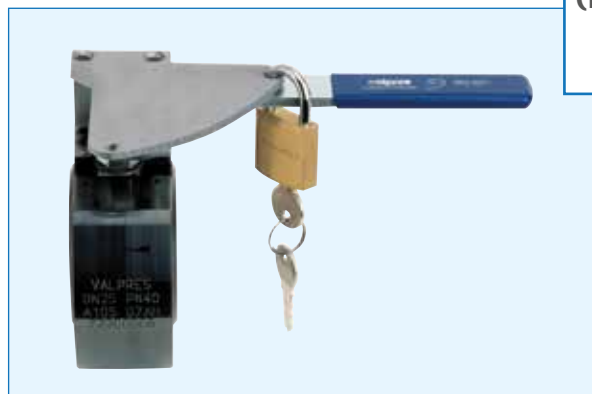

Part Number	DN	For use with	ISO Pad	Material	Not valid for
890075	1/2"	70 - 71	Ø36-F03	Stainless Steel	703000 (all sizes) 704000 (all sizes) 709000 (all sizes)
890056	1/2"	72			
	3/4"	70 - 71 - 72			
890057	1"	72 - 730008	Ø42-F04		
	1 1/4"				
890073	1"	70 - 71	Ø42-F04		
	1 1/4"				
890074	1 1/2"	70 - 71	Ø50-F05		
	2"				
890058	1 1/2"	72 - 730008	Ø50-F05		
	2"				
890059	2 1/2"	70 - 71 - 72 - 730008 - 776			
	3"	70 - 71 - 72 - 73 - 776			
	4"	70 - 71 - 72 - 73 - 776			
890060	5"	72 - 73 - 776			
	6"	72 - 73 - 776			
890061	6"	72 - 73 - 776			
	8"	72 - 73			

Valve with Gear Box Operator

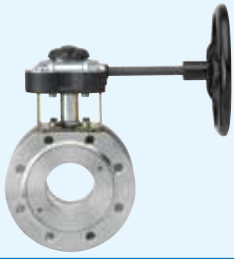

Manual Valve with Mechanical Limit Switches



Stainless Steel Tag



Manual Ball Valve with Limit Switch Box



Code	
RI4511	Kit for valve DN 15-20
RI4514	Kit for valve DN 25-32
RI4515	Kit for valve DN 40-50
RI4516	Kit for valve DN 65-80
RI4517	Kit for valve DN 100-125
RI4518	Kit for valve DN 150

Manual Butterfly Valve with Limit Switch Box



Code	
RI4334	Kit for valves from DN 50 to DN 150
RI4335	Kit for valves from DN 200 to DN 250
RI4336	Kit for valve DN 300

Flanged Diverter Ball Valve in Tandem

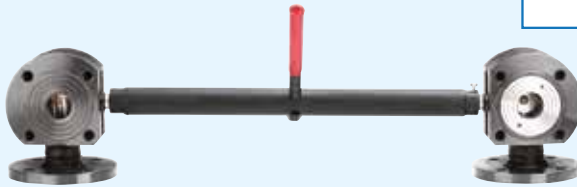

Valve Extension Stem



Part Number	Size	H	ØD	B	For use with type	Materials	Not valid for
890021	1/8"	55	20	M6	70	Carbon Steel	703000 (all sizes) 704000 (all sizes) 765 (all sizes) 766 (all sizes)
	1/4"	55	20	M6	70 - 71		
	3/8"	55	20	M6	70 - 71		
	1/2"	55	20	M6	70		
890022	1/2"	55	20	M6	71 - 72 - 76 - 776		
	3/4"	55	20	M6	70 - 71 - 72 - 76 - 776		
890023	1"	55	20	M6	70 - 71 - 72 - 73 - 76 - 776		
	1 1/4"	55	20	M6	70 - 71 - 72 - 73 - 76 - 776		
890024	1 1/2"	50	40	M6	70 - 71 - 72 - 73 - 76 - 776		
	2"	50	40	M6	70 - 71 - 72 - 73 - 75 - 776		
	2 1/2"	50	40	M6	75		
890025	2"	45	40	M8	76		
	2 1/2"	45	40	M8	70 - 71 - 72 - 73 - 76 - 776		
	3"	45	40	M8	70 - 71 - 72 - 73 - 776 - 75		
	4"	45	40	M8	75		
890026	3"	40	40	M8	76		
	4"	40	40	M8	70 - 71 - 72 - 73 - 76 - 776		
	5"	40	40	M8	72 - 73 - 75 - 76 - 776		